

FM PARTEC®

FM Partec S.p.A. - Via Europa 4 - Correggio (RE) Italy
Tel (+39) 0522 631055 - info@fmpartec.com

USE AND MAINTENANCE MANUAL





GREENBLOW PLUS

GREENBLOW®

ASSEMBLY INSTRUCTIONS (ENGLISH TRANSLATION) PRODUCT: GREENBLOW PLUS

Read the instructions completely and keep them for future reference, referring to the FM Partec technical specifications contained in the catalogue. If you are not in possession of these specifications, please ask for them to be provided.

1 TABLE OF CONTENTS AND INTERPRETATION OF SYMBOLS

1	TABLE OF CONTENTS AND SYMBOLS	Pag	1
2	FIELD OF APPLICATION	Pag	2
2.1	DESCRIPTION	Pag	2
2.2	COMPONENTS	Pag	2
2.3	INTENDED USE	Pag	2
2.4	OPERATING LIMITS	Pag	3
2.5	PROHIBITED USE	Pag	3
2.6	SAFETY	Pag	4
3	TECHNICAL CHARACTERISTICS	Pag	5
4	ASSEMBLY INSTRUCTIONS	Pag	5
5	TRANSPORT AND STORAGE	Pag	6
6	COMMISSIONING & INCORPORATION	Pag	7
6.1	MECHANICAL CONNECTIONS	Pag	7
6.2	ELECTRICAL CONNECTION	Pag	8
6.3	INVERTER	Pag	8
6.4	FIRST STARTUP	Pag	10
7	MAINTENANCE	Pag	10
8	MALFUNCTION/FAILURE	Pag	11
9	END OF LIFE	Pag	11
			
			
WARNING		DANGER	
		DANGER Electrocution risk	

2 FIELD OF APPLICATION

2.1 DESCRIPTION

The following instructions refer to item: 120029004*

The item is classified as partly completed machinery in accordance with directive 2006/42/EC.

2.2 COMPONENTS

- SYNCHRONOUS MOTOR WITH PERMANENT MAGNETS:
Power 2,2kW – Power supply 400V – Max. frequency 225Hz – 6 poles – Efficiency class IE4 – Connection B14
- MOTOR HOUSING:
Made of thermoplastic material: >PC/ABS-GF<
- Ø310 IMPELLER WITH HUB:
Made of thermoplastic material: >PA66+PA6I/X GF<
- INLET HOUSING:
Made of thermoplastic material: >PC/ABS-GF<

2.3 INTENDED USE

The centrifugal blower is intended to be incorporated into industrial machinery/plant with the function of blowing air taken from the surrounding environment onto materials needing to be cleaned, separated, dried or cooled.



ANY OTHER USE IS OUTSIDE THE MANUFACTURER'S RESPONSABILITY

This blower is classified as partly completed machinery and must not be put into operation until the final machine into which it is to be incorporated has been declared compliant with the provisions of directive 2006/42/EC. The use of an accessory such as tubes, couplings, diffusers or other at the airflow outlet section is recommended.



IN CASE OF USE OF AN INVERTER NOT PROVIDED BY FM PARTEC, THE WARRANTY WILL EXPIRE.

2.4 OPERATING LIMITS

- Make sure that the rated current does not exceed the value shown on the electric motor data plate (4,7 A);
- This centrifugal blower must not be used for blowing air which is toxic, saturated of vapour, corrosive or flammable, contains abrasive particles not originating from the ceramic environment, or is at a temperature outside the range -20°C / +60°C;
- It is possible to use it at higher power frequencies via inverters up to a maximum of 225Hz/4500RPM (see sticker on the inlet casing of the GreenBlow);
- Use as a suction device is possible only in the presence of air free and/or previously purified of abrasive particles, for example by a cyclone separator.

POLYMER	PC/ABS-GF			PA66+ PA6I/X GF		
THERMAL PROPERTIES	-20°C/+90°C			-30°C/+110°C		
CHEMICAL PROPERTIES	A	B	I	A	B	I
	+	+	-	-	+	++





A=ACIDS; B=BASES; I=HYDROCARBONS;
 - POOR; + GOOD; ++ VERY GOOD

2.5 PROHIBITED USE



- Do not use to suck liquids and/or solids in the absence of purification upstream of the blower;
- Do not use in areas with a potentially explosive atmosphere;
- Do not put tools in the inlet mouth, and limbs in the outlet when the blower is operating;
- Do not carry out maintenance or other operations with the motor powered and/or the impeller moving.

2.6 SAFETY

ZONE	HAZARD	CAUTIONS
Inlet 	 Capture of objects (e.g. paper, rags ecc.)	Not to approach at suction grid rags or other objects that could be captured.
Discharge outlet	 Ejection of objects/debris sucked by discharge inlet, contact with the moving impeller.	Connect always a diffuser/tube/air knife at the discharge outlet. In case of occasional free outlet functioning, avoid to stay along the path of the air flow.
Terminal box	Electrocutation	Do not operate in presence of electric tension.
Impeller	 Failures/contacts with the carters caused by excessive centrifugal force.	Do not exceed RPM/maximum frequency (4500RPM/225Hz) indicated on the sticker placed on the inlet casing.
Carter	Shipping failures	Incorporate the blower into the machine after transporting the machine to the place of use.

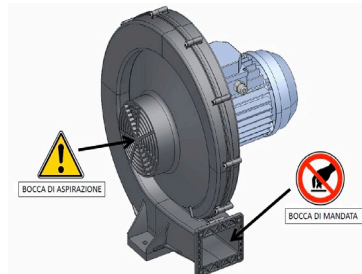

FIGURE 1

3 TECHNICAL FEATURES

In the lower part of the inlet casing, the blower has a sticker giving the efficiency data (FIGURE 2).

For more data about motor, refer to the plate on the electric motor.

FAPARTEC	
Overall efficiency (50Hz, current from electricity grid, no inverter)	0,5
Measurement category	B
Efficiency category	Total
Efficiency grade N	64

FIGURE 2

4 BLOWER COMPONENT ASSEMBLY INSTRUCTIONS

NB: Although the blower components have been specifically designed to minimise the risk of assembly errors, the following instructions must be observed scrupulously.

1. Secure the electric motor to the motor housing and fasten with n°4 low cylinder-head M6x20 screws UNI 9327 (bolts supplied) with a max. torque of 8Nm (FIGURE 3);
2. Secure the Ø310 impeller to the electric motor shaft using n°1 M5 socket head cap screw UNI 5931 and washer UNI 6593 (bolts supplied). Tighten to a max. torque of 8Nm.
We recommend using thread lock on the screw for more effective locking (Loctite 270 or similar) (FIGURE 4);
3. Secure the inlet housing to the previously assembled group using n°12 KC40 x 30 screws (bolts supplied).
Tighten the screws to a max. torque of 5Nm (FIGURE 5).

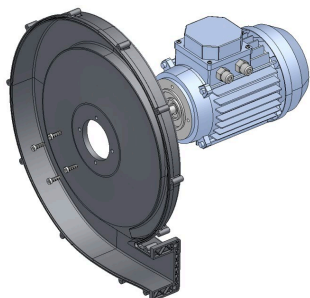

FIGURE 3

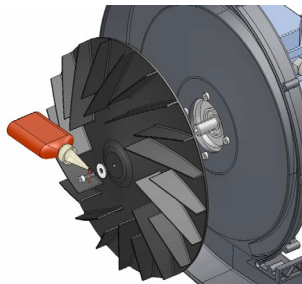

FIGURE 4

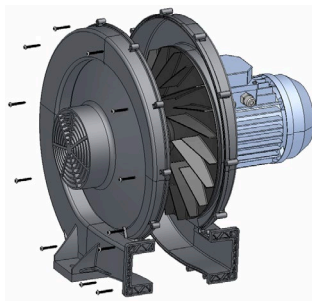

FIGURE 5

5 TRASPORT AND STORAGE

On arrival, check that the packaging and contents are not damaged.

In event of damage, contact the supplier.

A single item can be moved by hand, but multiple items must be handled using appropriate equipment according to the volume and weight of the packaging.

Dispose of packaging materials properly.

6 COMMISSIONING AND INCORPORATION OF THE MACHINE

MODIFICATIONS AND CUSTOMISATIONS ARE NOT PERMITTED IF THESE ARE LIABLE TO AFFECT THE INTEGRITY OF THE BLOWER.

6.1 MECHANICAL CONNECTIONS

1. Secure the blower to a plant/machine using M10 bolts (not supplied). We recommend the use of a washer of appropriate size (FIGURE 6).
In case of excessive vibrations, insert anti-vibration supports between the blower and the frame;
2. Secure the diffuser (or other accessory) to the outlet section using n°4 M6 hex head bolts UNI EN 24017, n°4 M6 nuts UNI EN 24032, n°8 Ø6 washers UNI 6592 (bolts supplied with the diffusers). Tighten to a max. torque of 8Nm (FIGURE 7);
3. Insert the possible filter on the inlet section, fixing it using the fastening band (supplied with the filter) (FIGURE 8).

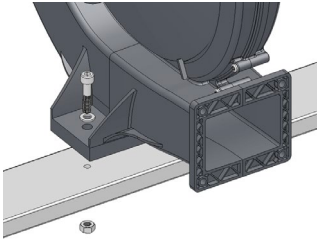

FIGURE 6

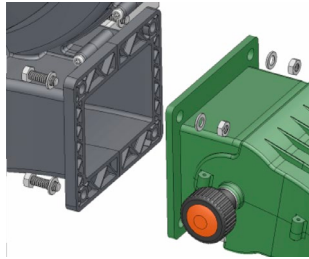

FIGURE 7

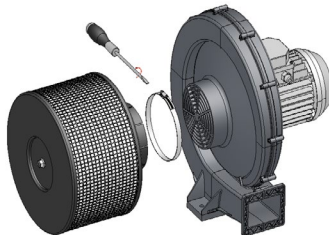

FIGURE 8

6.2 ELECTRIC CONNECTIONS

Make the electrical star connection according to the diagram provided inside the motor's terminal box, connecting the phases to U1, V1 and W1 and the grounding to one of the screws fastened to the casing (FIGURE 9).

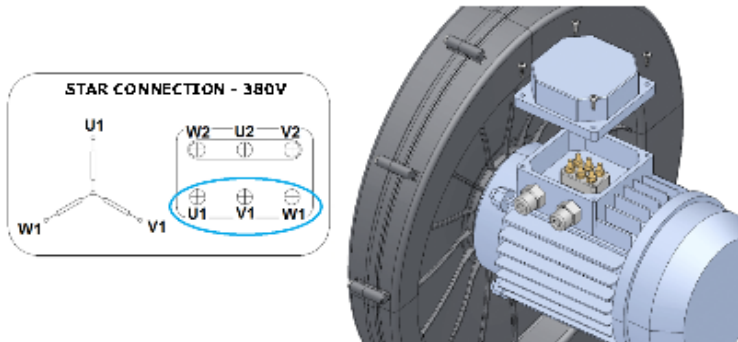

FIGURE 9

6.3 INVERTER

The synchronous motor with permanent magnets requires a dedicated inverter for its operations, therefore as accessory FM Partec supplies (recommended choice) 2 different inverters models with integrated distribution board and 2 inverter model without distribution board. Please refer to the specific inverters instruction manuals for correct functioning with FM Partec blowers.

The inverters are supplied appropriately programmed and protected by a password, so that do not require autotuning functions and/or other parameter changes.

The programming of the inverters has been optimized to limit noise and vibrations, **so it is strongly discouraged to reset the factory parameter of the inverter**, because the sole autotuning function is not sufficient for using the blower.

N.B. IN CASE OF PARAMETERS RESET AND/OR PASSWORD DISCLOSURE, WARRANTY BECOMES NULL AND VOID.

Only if FM Partec inverters are NOT used (unrecommended choice due to warranty expiration), the following table gives the main parameters for programming to which it is advisable to combine an autotuning function.

It is extremely important to identify an inverter setting such as to minimize the vibrations of the blower thus avoiding interference between the impeller and the casings.

In case of troubles in programming the inverter parameters, it is advisable to contact the nearest service center of your inverter supplier.

PARAMETR	VALUE	UNIT
Acceleration time (suggested value)	10	s
Deceleration time (suggested value)	10	s
Rated speed	4500	RPM
Motor power at rated speed	2.2	kW
Rated torque	4,7	Nm
Peak torque	14,1	Nm
Number of poles	6	/
Connection	Y	/
Voltage constant	0,61	Vs
Torque constant	0,98	Nm/A
Winding line to line resistance	2,2	Ω
Winding line to line inductance	8,3	mH
B.E.M.F. at rated speed	288	Vrms
Rated current	4,7	A
Efficiency level	IE4	/
Motor efficiency	86,4	%
Base frequency	225	Hz
Maximum frequency	225	Hz
Supply voltage to motor	400	V

To avoid malfunction and/or damage to the inverter:

- Refer to the inverter instruction manual;
- Avoid direct exposure to sunlight;
- Use shielded cables with a max. length of 25m.

6.4 FIRST STARTUP

- Do not start the machine/system without having secured the blower;
- Test blower operation, checking that the impeller rotates in the direction indicated by the arrows on the casing; If the rotation direction is incorrect, appropriately modify the electrical connection by inverting the phases inside the terminal block or by acting on the inverter;
- Once incorporated into the machine, check that the blower does not vibrate abnormally during operation; Otherwise, make sure all components have been assembled correctly and/or insert anti-vibration supports.

7 MAINTENANCE

During maintenance/cleaning, use specific PPE for arm protection.

<p>Components functionality</p>	<p>At monthly intervals check that all bolts and screws are perfectly tightened and that plastic parts do not show signs of damage or deterioration: if they do, consider replacing them to restore the necessary conditions of safety.</p> <p>Carefully look after all fixing bolts and screws during maintenance work with the plant stopped and refit them (as described in the installation procedure) before restarting the plant/machine.</p> <p>If bolts or screws are missing, new ones must be used.</p>
<p>Cleaning</p>	<p>At monthly intervals check the cleaning of all components, in particular of the impeller. Cleaning operations must be performed strictly with the machine turned off and after the impeller has come to a standstill.</p> <p>It is possible to use a wet cloth to clean the external surfaces and (after removing the diffuser/tube) the internal surfaces.</p>
<p>Filter checking</p>	<p>At weekly intervals check the state of the suction filter or use the specific function of predictive maintenance available into the inverter CFP2000-CP2000. In case of excessive dirt of the filter cause a reduction of the performances, clean or replace the filter.</p>

8 MALFUNCTION / FAILURE

In case of malfunction during use, disconnect the power supply and have the cause of the fault checked by professionally qualified personnel.

In case of work requiring partial or complete removal of the above-mentioned centrifugal blower components, make sure the impeller has stopped moving, the blower is disconnected from mains power and that the machine/system is at a standstill.

MALFUNCTION	CAUSE AND POSSIBLE SOLUTION
Noisy blower, reduced air speed.	Controllare se il verso di rotazione della girante è lo stesso indicato dalle frecce poste sul carter di aspirazione. In caso contrario scambiare tra loro 2 phases della morsettiera del motore.
Failed start-up of 1 of the 2 blowers that supply a single air knife with two inlets.	Not simultaneous operation of the blowers. Operate the blowers <u>at the same time</u> and/or extend the acceleration ramps.
Overload inverter – Fault Overload (DELTA inverter)	Too short acceleration/deceleration ramps. Extend the ramps.

9 END OF LIFE

The materials used by FM, whether plastic or metal, must be treated as special waste and therefore should not be released into the environment.

Disassembly	In order to separate motor, plastic material and metal parts, follow in reverse the assembly instructions.
Disposal	Refer to the legislation in force in the country of employment.

IU014-D24-EN